

HAM-105&HAM-109



Performance Gas Spring Aluminum Monitor Arms

When Style Meets Function

Designed with a compact V shape, the sleek arms release space and free you from desktop chaos. It improves work productivity by supporting side-by-side monitors, allowing for easy and personalized adjustments.



HAM-105&HAM-109

Performance Gas Spring Aluminum Monitor Arms

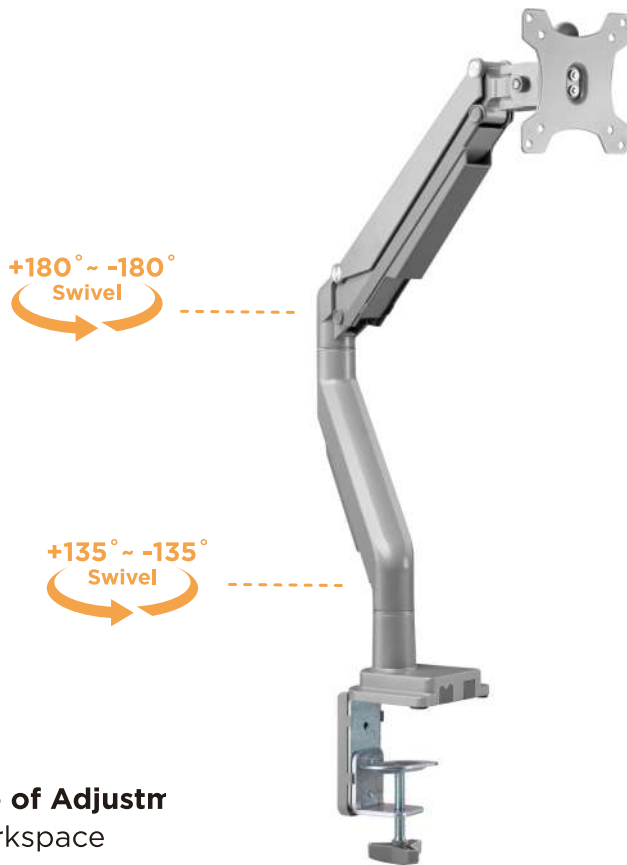

Wide Range of Adjustr
frees-up workspace

Clamp & Grommet Mounts Included
mounts to most any style desktop



HAM-105&HAM-109
Performance Gas Spring
Aluminum Monitor Arms

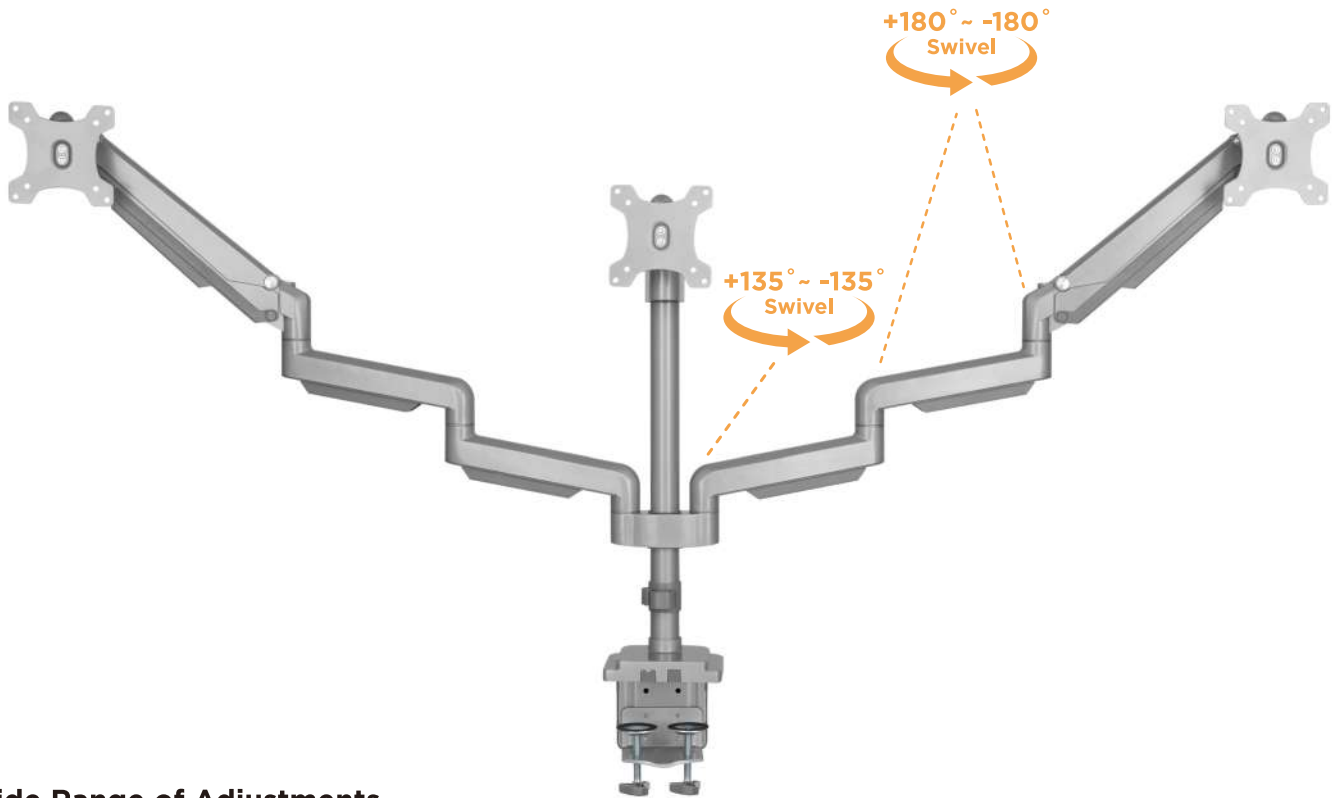

Wide Range of Adjustments
frees-up workspace

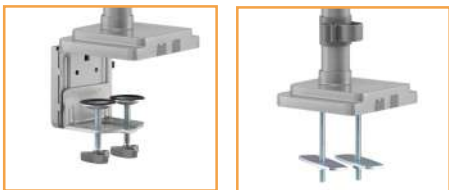

Clamp & Grommet Mounts Included
mounts to most any style desktop

HAM-105&HAM-109

Performance Gas Spring Aluminum Monitor Arms



HAM-105

For Single Monitor

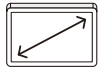

Screen Size
13"-32"

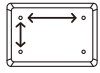

VESA Compatible
75x75 100x100



Weight Capacity
1-9kg/2.2-19.8lbs



Tilt Range
+90° - -90°

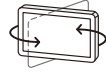

Swivel Range
+90° - -90°



Screen Rotation
+90° - -90°



Detachable
VESA Plate

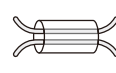

Cable
Management



Curved Monitor

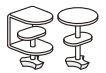

Clamp & Grommet
Installation

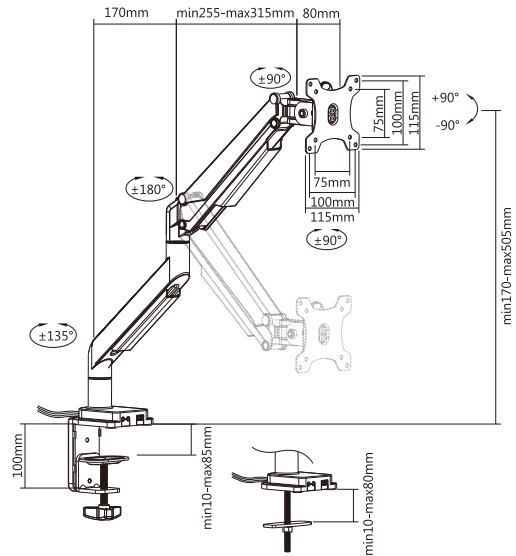

HAM-109

For Triple Monitors

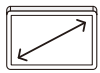

Screen Size
17"-30"

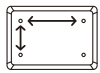

VESA Compatible
75x75 100x100



Weight Capacity
1-7kg/2.2-15.4lbs
(x3)



Tilt Range
+90° - -90°

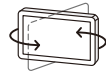

Swivel Range
+90° - -90°



Screen Rotation
+90° - -90°



Detachable
VESA Plate

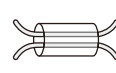

Cable
Management



Curved Monitor

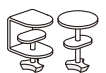

Clamp & Grommet
Installation

